

Register your product and get support at
www.philips.com/welcome

AZ1048



EN User manual

PHILIPS

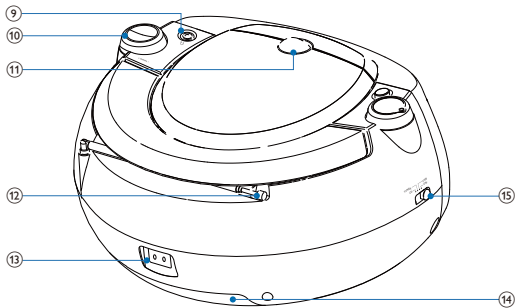
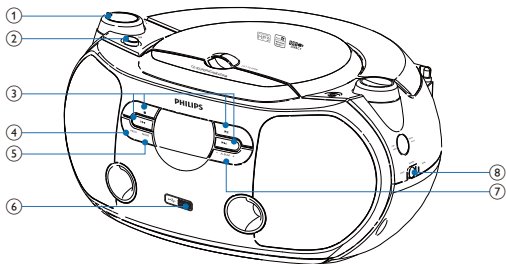

1 Important

Safety

Important Safety Instructions

- ① Read these instructions.
- ② Keep these instructions.
- ③ Heed all warnings.
- ④ Follow all instructions.
- ⑤ Do not use this apparatus near water.
- ⑥ Clean only with dry cloth.
- ⑦ Do not block any ventilation openings. Install in accordance with the manufacturer's instructions.
- ⑧ Do not install near any heat sources such as radiators, heat registers, stoves, or other apparatus (including amplifiers) that produce heat.
- ⑨ Protect the power cord from being walked on or pinched, particularly at plugs, convenience receptacles, and the point where they exit from the apparatus.
- ⑩ Only use attachments/accessories specified by the manufacturer.

- ⑪ Use only with the cart, stand, tripod, bracket, or table specified by the manufacturer or sold with the apparatus. When a cart is used, use caution when moving the cart/ apparatus combination to avoid injury from tip-over.



- ⑫ Unplug this apparatus during lightning storms or when unused for long periods of time.
- ⑬ Refer all servicing to qualified service personnel. Servicing is required when the apparatus has been damaged in any way, such as power-supply cord or plug is damaged, liquid has been spilled or objects have fallen into the apparatus, the apparatus has been exposed to rain or moisture, does not operate normally, or has been dropped.
- ⑭ **Battery usage CAUTION** – To prevent battery leakage which may result in bodily injury, property damage, or damage to the unit:
- Install all batteries correctly, + and - as marked on the unit.
 - Do not mix batteries (old and new or carbon and alkaline, etc.).
 - Remove batteries when the unit is not used for a long time.
 - The batteries shall not be exposed to excessive heat such as sunshine, fire or the like.
- ⑮ Apparatus shall not be exposed to dripping or splashing.
- ⑯ Do not place any sources of danger on the apparatus (e.g. liquid filled objects, lighted candles).

- 17 This product may contain lead and mercury. Disposal of these materials may be regulated due to environmental considerations. For disposal or recycling information, please contact your local authorities or the Electronic Industries Alliance: www.eiae.org.



Warning

- Never remove the casing of this apparatus.
- Never lubricate any part of this apparatus.
- Never place this apparatus on other electrical equipment.
- Keep this apparatus away from direct sunlight, naked flames or heat.
- Never look into the laser beam inside this apparatus.
- Ensure that you always have easy access to the power cord, plug or adaptor to disconnect this apparatus from the power.



Caution

- Use of controls or adjustments or performance of procedures other than herein may result in hazardous radiation exposure or other unsafe operation.

Notice

Any changes or modifications made to this device that are not expressly approved by Philips Consumer Electronics may void the user's authority to operate the equipment.



This product complies with the radio interference requirements of the European Community.

This product complies with the requirements of the following directives and guidelines: 2004/108/EC + 2006/95/EC



The making of unauthorized copies of copy-protected material, including computer programs, files, broadcasts and sound recordings, may be an infringement of copyrights and constitute a criminal offence. This equipment should not be used for such purposes.

Recording and playback of material might require consent. See Copyright Act 1956 and The Performer's Protection Acts 1958 to 1972.

Recycling



Your product is designed and manufactured with high quality materials and components, which can be recycled and reused. When you see the crossed-out wheel bin symbol attached to a product, it means the product is covered by the European Directive 2002/96/EC:



Never dispose of your product with other household waste. Please inform yourself about the local rules on the separate collection of electrical and electronic products. The correct disposal of your old product helps prevent potentially negative consequences on the environment and human health.

Your product contains batteries covered by the European Directive 2006/66/EC, which cannot be disposed of with normal household waste.

When you see the crossed-out wheel bin symbol with the chemical symbol 'Pb', it means that the batteries comply with the requirement set by the directive for lead:



Please inform yourself about the local rules on separate collection of batteries. The correct disposal of batteries helps prevent potentially negative consequences on the environment and human health.

Environmental information

All unnecessary packaging has been omitted. We have tried to make the packaging easy to separate into three materials: cardboard (box), polystyrene foam (buffer) and polyethylene (bags, protective foam sheet.)

Your system consists of materials which can be recycled and reused if disassembled by a specialized company. Please observe the local regulations regarding the disposal of packaging materials, exhausted batteries and old equipment.

Norge

Typeskilt finnes på apparatens underside.

Observer: Nettbryteren er sekundært innkoplet. Den innebygde nettdelen er derfor ikke frakoplet nettet så lenge apparatet er tilsluttet nettkontakten.

For å redusere faren for brann eller elektrisk støt, skal apparatet ikke utsettes for regn eller fuktighet.

This apparatus includes this label:



2 Your CD Soundmachine

Congratulations on your purchase, and welcome to Philips! To fully benefit from the support that Philips offers, register your product at www.philips.com/welcome.

Introduction

With this unit, you can enjoy audio from discs, USB devices, or radio stations. You can also program the play sequence of tracks, and you can enhance the sound with the Dynamic Bass Boost feature.



What's in the box

Check and identify the contents of the package:

- CD Soundmachine
- AC power cord
- User Manual

Overview of the main unit

- ① **VOLUME**
 - Adjust volume level.

- ② **DBB**
- Turn the bass enhancement on/off.
- ③ **■**
- Stop CD play.
 - Erase a CD program.
- ▶||**
- Start or pause CD play.
- ◀◀/▶▶**
- Select the previous/next track.
 - Fast search backwards/forwards within the current track.
- ④ **PROG**
- Program tracks and browse the program.
- ⑤ **MODE**
- Select a play mode: REPEAT or SHUFFLE.
- ⑥ ****
- USB socket.
- ⑦ **ALBUM +/-**
- Skip to the next/previous album in an MP3-CD.
- ⑧ **BAND**
- Select a wave band.
- ⑨ ****
- Jack for headphone.
- ⑩ **TUNING +/-**
- Tune to radio stations.
- ⑪ **LIFT TO OPEN**
- Open/Close the CD compartment.

- ⑫ **Telescopic antenna**
 - Improve FM reception.
- ⑬ **AC MAINS~**
 - Socket for the power cord.
- ⑭ **Battery compartment**
- ⑮ **Source selector: CD, USB, TUNER, OFF**
 - Select CD, USB, radio, or MP3 source.
 - Switch to standby mode.

3 Get started



Caution

- Use the controls only as stated in this user manual.
- Always follow the instructions in this chapter in sequence.

If you contact Philips, you will be asked for the model and serial number of your player. The model number and serial number are on the bottom of your player. Write the numbers here:

Model No. _____

Serial No. _____

Install batteries

- 1 Open the battery compartment.

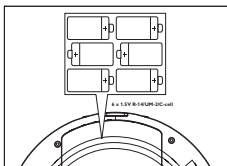

- 2 Insert 6 x 1.5V R14/UM-2/C-cell batteries with correct polarity (+/-) as indicated.
- 3 Close the battery compartment.



Tip

- If you want to save battery life, use the supplied power cord.

Connect AC power



Warning

- Risk of product damage! Ensure that the power supply voltage corresponds to the voltage printed on the back or the underside of the product.
- Risk of electric shock! When you unplug the AC adaptor, always pull the plug from the socket. Never pull the cord.



Note

- Install the unit near the power supply socket and where the AC power plug can be easily reached.

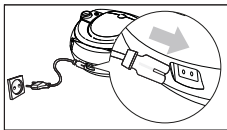

- 1 Connect the power cord to:
 - the **AC MAINS~** socket on the main unit.
 - the power supply socket.



Tip

- To save energy: After use, set the source selector to **OFF**. To turn off the CD Soundmachine, disconnect the plug from the power supply socket.

4 Play

Play a CD



Note

- You cannot play CDs encoded with copyright protection technologies.

You can play commercially available audio CDs:





- CD-Recordables (CD-R)
 - CD-Rewritables (CD-RW)
 - MP3-CDs
- 1** Push the source selector to **CD**.
 - 2** Lift the lid of the CD compartment.
 - 3** Insert a CD with the printed side facing up.
 - 4** Close the CD lid gently.
↳ The total number of tracks is displayed.
 - 5** Press **▶||** to start play.
↳ **[▶]** is displayed.
 - To pause CD play, press **▶||**.
 - To resume CD play, press **▶||** again.
 - To stop CD play, press **■**.

Play from USB



Note

- Ensure that the USB device contains playable audio contents for supported formats. (See "USB playability information")

- 1 Flip the USB socket cover.
- 2 Plug the USB device into the  socket.
- 3 Push the source selector to **USB**.
- 4 Press  to start play.
 - To pause/resume play, press .
 - To stop play, press .
 - To search within an audio file, press and hold , then release to resume normal play.

Listen to radio

- 1 Switch the source selector to **TUNER**.
- 2 Switch **BAND** to **FM** or **MW**.
- 3 Turn **TUNING +/-** to find a station.



Tip

- To improve FM reception, you can extend, incline or turn the telescopic antenna for best reception.
- To improve MW reception, turn the CD Soundmachine to face a different direction.

5 Play options

Program play sequence

You can store up to 30 tracks in the desired sequence.

- 1 In stop mode, press **PROG** to start to program play sequence.
↳ **[PROG]** and **[P01]** are displayed.



- 2 Press **ALBUM +/-** to select an album.
This step is only applicable for MP3 and WMA-CDs.
- 3 Press **◀◀▶▶** to select a track.
- 4 Press **PROG** to store the track.
↳ **[PROG]** and **[P02]** are displayed.
- 5 Repeat steps 2 to 4 to select and store all tracks.
↳ When all 30 tracks are stored, no more tracks can be selected and the display shows **[PROG]** and **[FUL]**.
- 6 To play program, press **▶||**.
 - In stop mode, press **PROG** repeatedly to browse stored tracks.
 - To cancel program, press **■** twice.



Tip

- When program play stops, the CD Soundmachine returns to normal play. To play program again, repeat steps 1 to 6.

Select play modes

Repeat play

You can repeat a track, an MP3 album, a disc, or a program.

- [↻] – plays the current track continuously
 - [↻ ALL] – repeats the entire CD/program
- 1 During play, press **MODE** repeatedly until the display shows the repeat icon.
 - Repeat one track.



- Repeat a program.



- To stop repeat play, press **MODE** repeatedly until the repeat icon is no longer displayed.

Shuffle play

You can play all tracks in random order.

- 1 During play, press **MODE** repeatedly until the display shows the shuffle icon.



- To stop shuffle play, press **MODE** again.

Select a track

- 1 During play, press **◀◀▶▶** to select a track.

Select an album

For MP3-CDs only.

- 1 During play, press **ALBUM +/-** to select an album.

Find a passage within a track

- 1 During play, press and hold **◀◀▶▶**.
↳ The CD is played at high speed and with reduced volume.
- 2 Release **◀◀▶▶** to resume normal play.



Tip

- When search reaches the end of the last track, the CD stops.

6 Product information



Note

- Product information is subject to change without prior notice.

Specifications

Disc

Laser Type	Semiconductor
Disc Diameter	12cm/8cm
Support Disc	CD-DA, CD-R, CD-RW, MP3-CD, WMA-CD
Audio DAC	24Bits / 44.1kHz
Total Harmonic Distortion	<1%
Frequency Response	60Hz -16kHz
S/N Ratio	>62dBA

Tuner

Tuning Range	FM: 87.5 - 108MHz; MW: 530 - 1600kHz
Total Harmonic Distortion	<3%
Signal to Noise Ratio	>50 dB

Tape deck

Frequency response - Normal tape (type I)	125 - 8000 Hz (8 dB)
Signal-to-noise ratio - Normal tape (type I)	40 dBA
Wow and flutter	<0.4% JIS

General

Dimensions (main unit) (W x H x D)	320 x 275 x 175 mm
Weight (main unit)	1.7 kg
Power supply	DC: 9V 1.5A AC: 230V
Power consumption - Active - Standby	<12 W 0.7W
Power output	1W x 2 RMS
Operating temperature range	- 10 °C - +50 °C 14 °F - 122 °F

Supported MP3 disc formats

- ISO9660, Joliet
- Maximum title number: 512 (depending on file name length)
- Maximum album number: 255
- Supported sampling frequencies: 32 kHz, 44.1kHz, 48 kHz
- Supported Bit-rates: 32~256 (kbps), variable bit rates

USB playability information

Compatible USB devices:

- USB flash memory (USB 2.0 or USB1.1)
- USB flash players (USB 2.0 or USB1.1)
- memory cards (requires an additional card reader to work with this apparatus)

Supported formats:

- USB or memory file format FAT12, FAT16, FAT32 (sector size: 512 bytes)
- MP3 bit rate (data rate): 32-320 Kbps and variable bit rate
- WMA v9 or earlier
- Directory nesting up to a maximum of 8 levels
- Number of albums/ folders: maximum 99
- Number of tracks/titles: maximum 999
- ID3 tag v2.0 or later
- File name in Unicode UTF8 (maximum length: 128 bytes)

Unsupported formats:

- Empty albums: an empty album is an album that does not contain MP3/WMA files, and is not be shown in the display.
- Unsupported file formats are skipped. For example, Word documents (.doc) or MP3 files with extension .dlf are ignored and not played.
- AAC, WAV, PCM audio files
- DRM protected WMA files (.wav, .m4a, .m4p, .mp4, .aac)
- WMA files in Lossless format

7 Troubleshooting



Warning

- Risk of electric shock. Never remove the casing of the player.

To keep the warranty valid, never try to repair the system yourself. If you encounter problems when using the player, check the following points before requesting service. If the problem remains unsolved, register your player and get support at www.philips.com/welcome.

No power

- Ensure that the power cord is connected securely.
- Ensure that there is power at the power supply socket.
- Ensure that the batteries are installed correctly.

No sound

- Adjust the volume.
- Ensure that the track played is of a compatible format.

Display does not function properly./No reaction to operation of any of the controls.

- 1** Disconnect the AC power cord.
- 2** Connect the AC power cord after a few seconds.

Cannot play disc

- Ensure that the disc label is inserted with the printed side facing up.
- Wipe the disc with fibre cleaning cloth from the centre to the edge in a straight line.
- This disc may be defective. Play another disc.
- Ensure that the CD is a finalised CD/CD-R/CD-RW.
- Ensure that the laser lens is clean.
- Ensure that the CD is not encoded with copyright protection technologies.

The CD skips tracks

- Ensure that the CD is not damaged or dirty.
- Ensure that program/shuffle mode is deactivated.

USB device not supported

- The USB device is incompatible with the apparatus. Try another one.

Poor radio reception

- Increase the distance between the unit and your TV or VCR.
- Fully extend the FM antenna.
- Connect an outdoor FM antenna instead.



© 2010 Koninklijke Philips Electronics N.V.

All rights reserved.

AZ1048_12_UM_V1.0

